

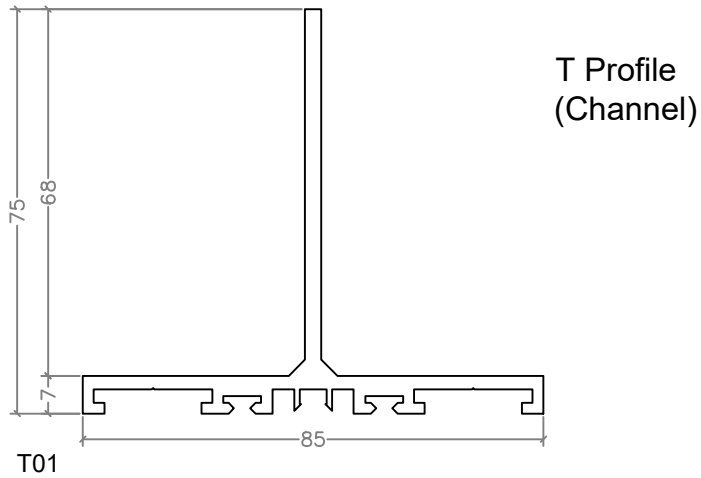

code	profile	profile features	code	profile	profile features
------	---------	------------------	------	---------	------------------



T01

colour : ral

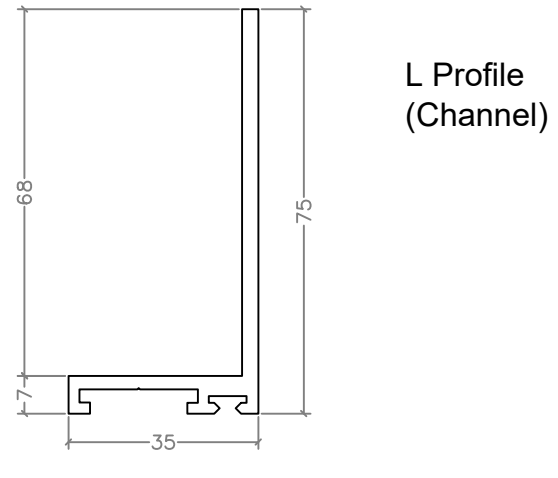

L01

colour : ral

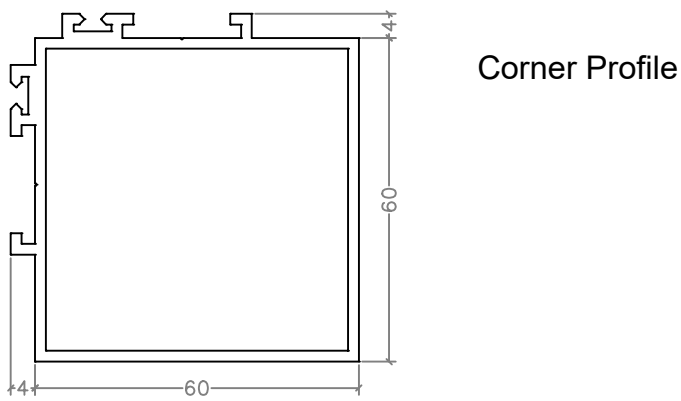

K01

colour : ral

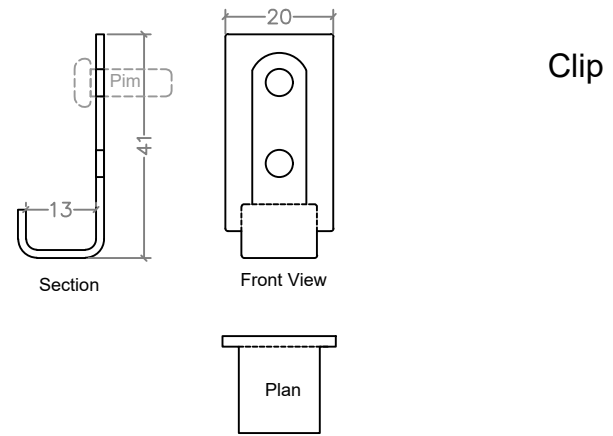

KL01

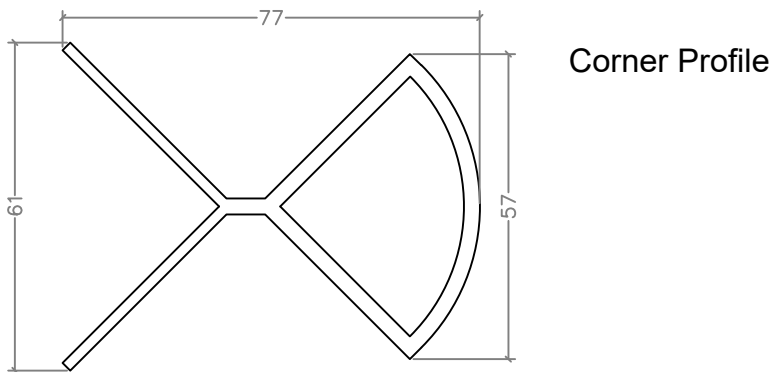

T 05

colour : ral

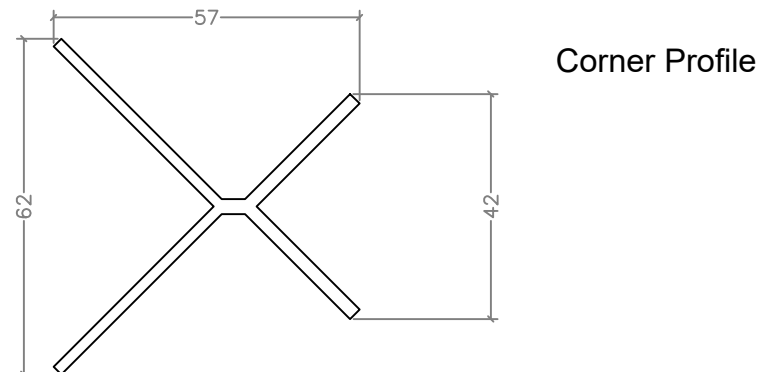

.....

colour : ral

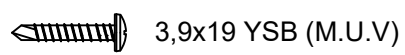
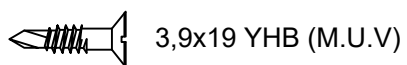

EPDM Rubber Profile



Pin

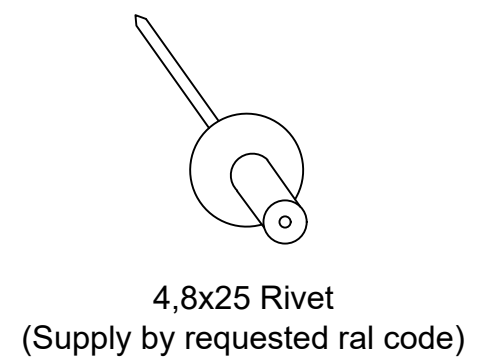
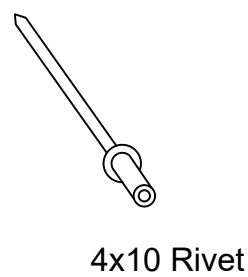
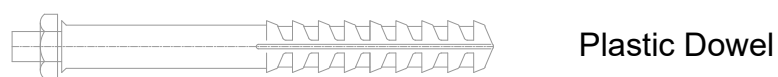
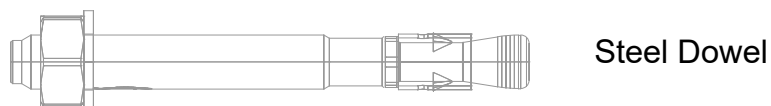

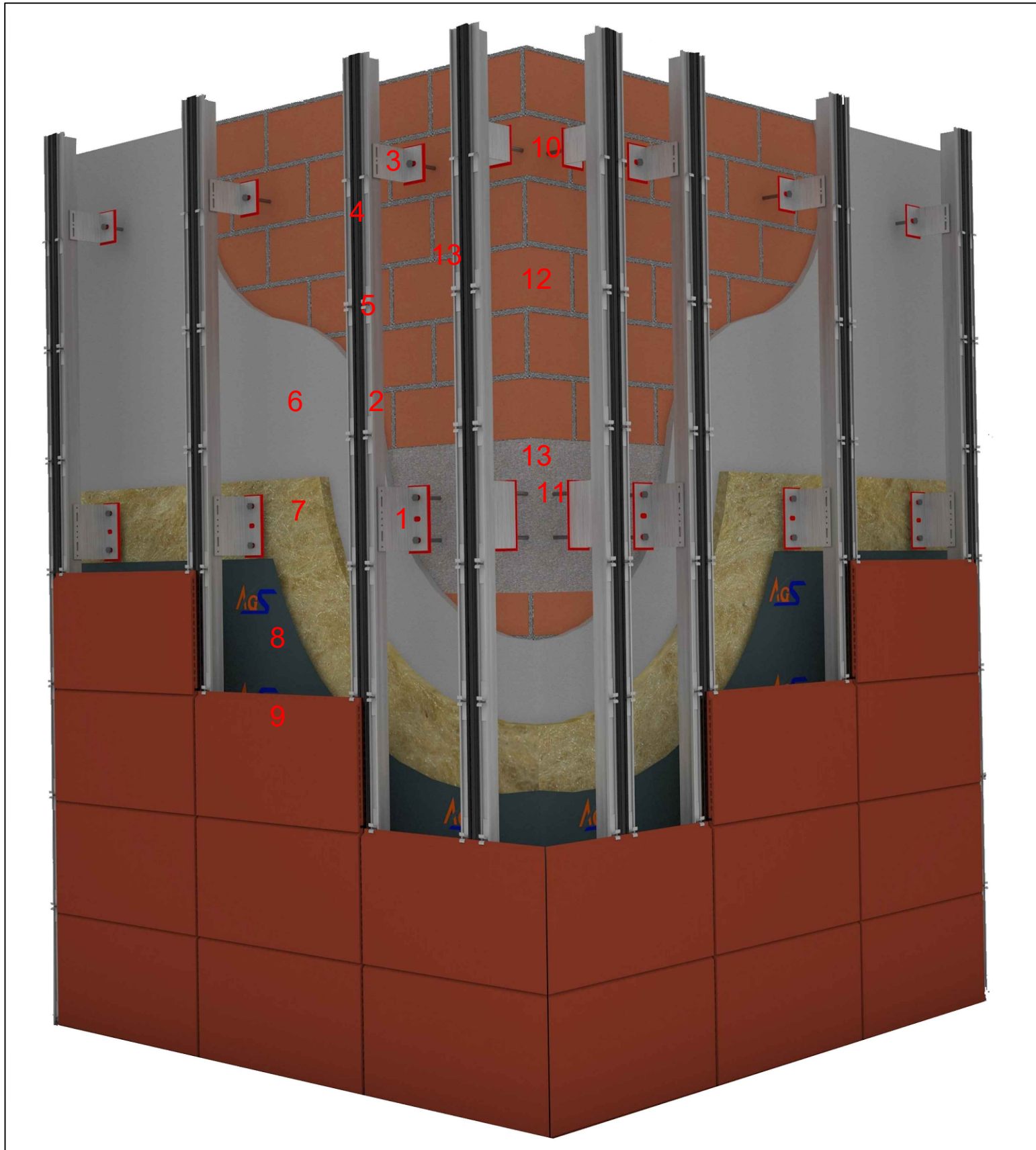

1. IZOFIX MAIN BRACKET
2. T PROFILE
3. IZOFIX SUPPORT BRACKET
4. EPDM RUBBER PROFILE
5. CLIP
6. PLASTER
7. THERMAL INSULATION
8. WATERPROOF MEMBRANE
9. TERRACOTTA
10. PLASTIC DOWEL
11. STEEL DOWEL
12. BRICK BLOCK
13. CONCRETE BEAM

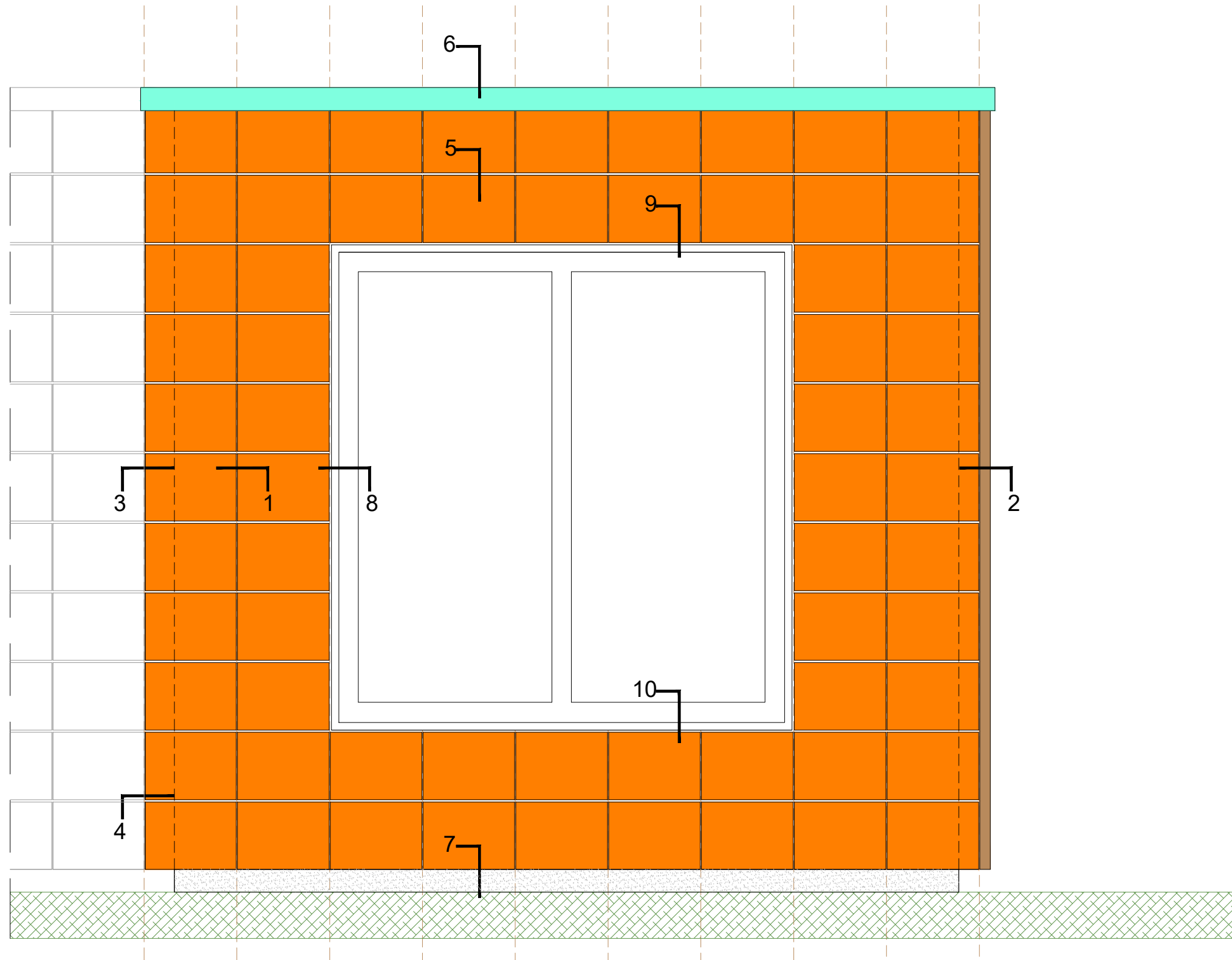

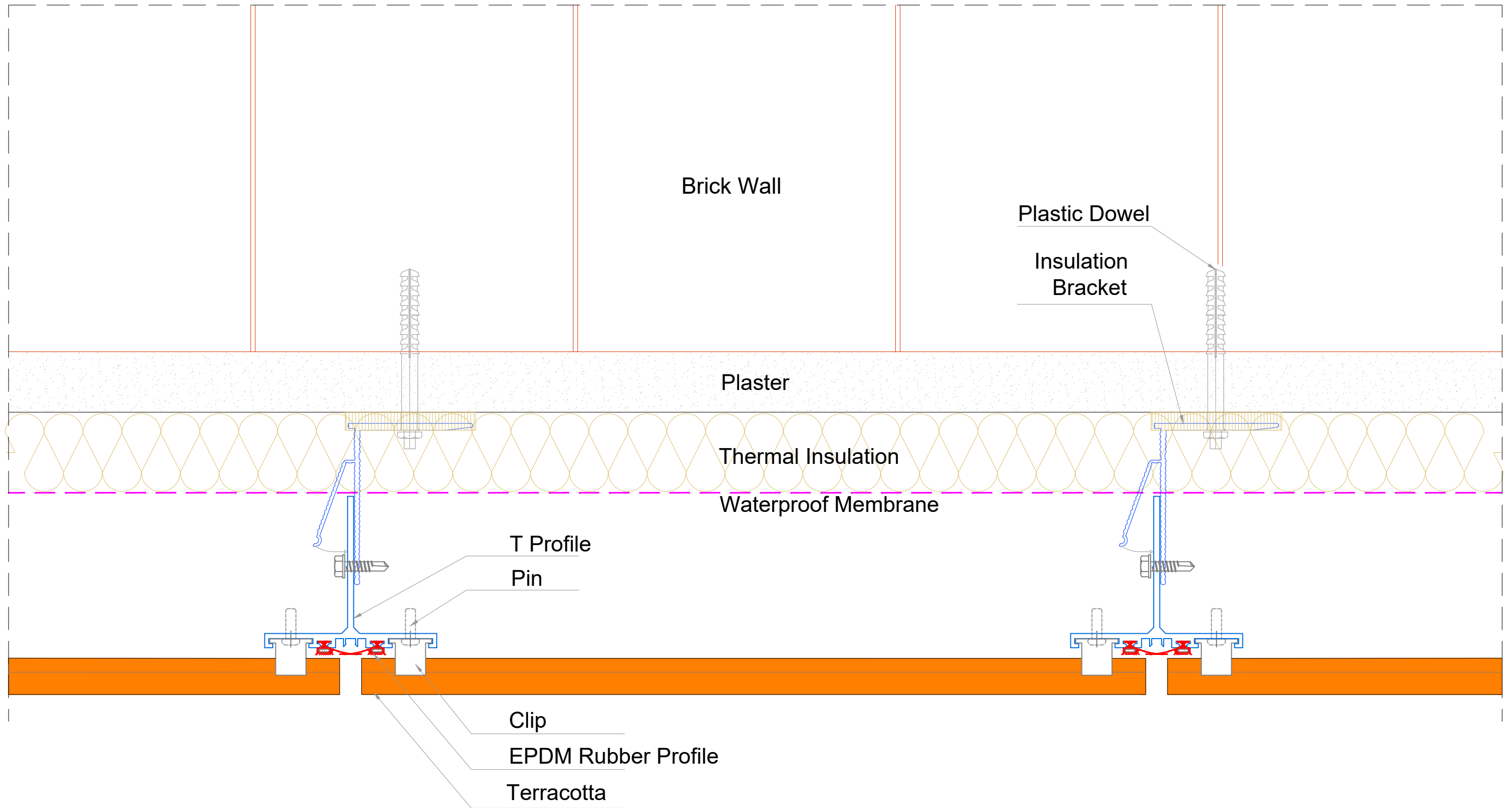

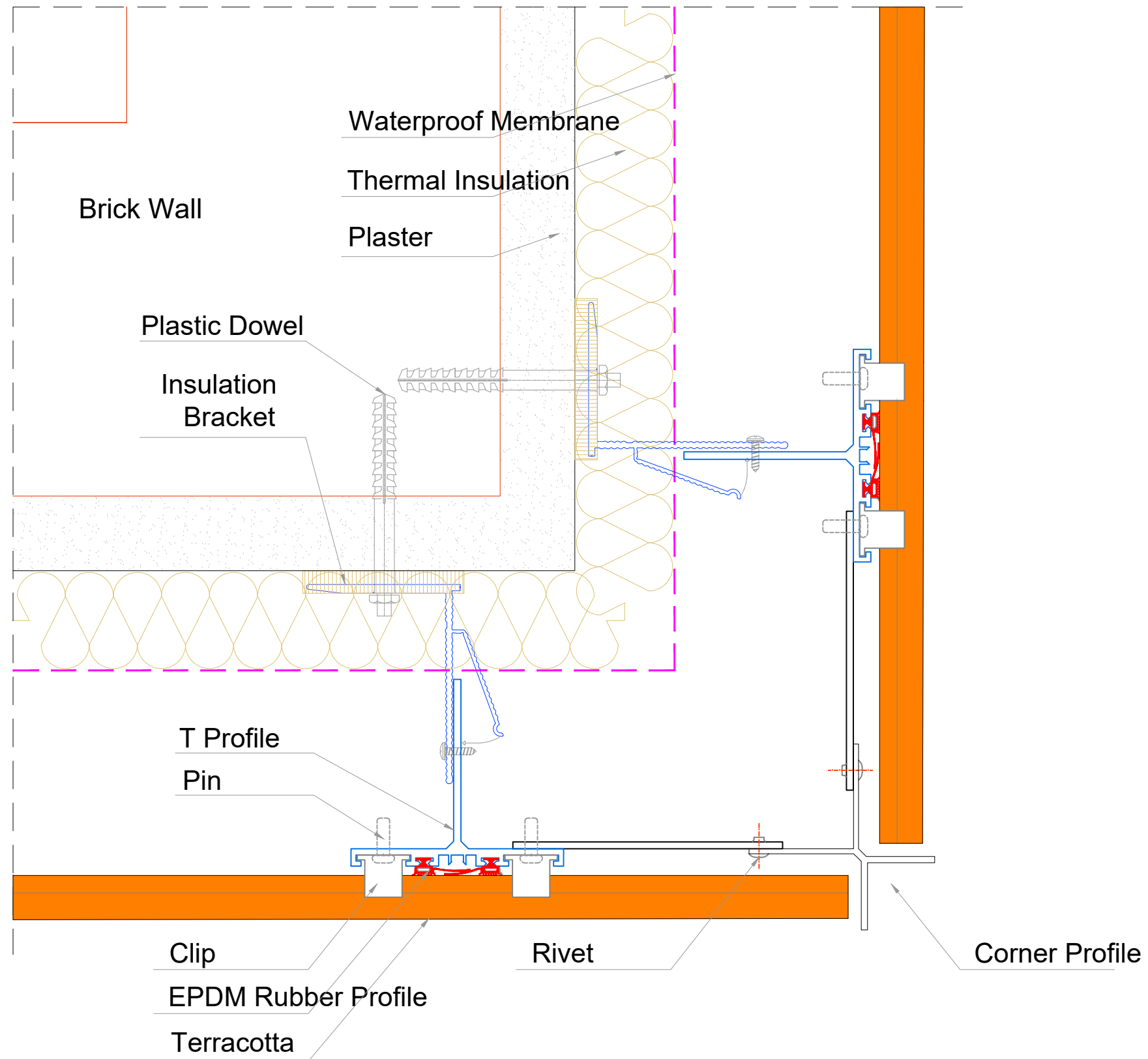

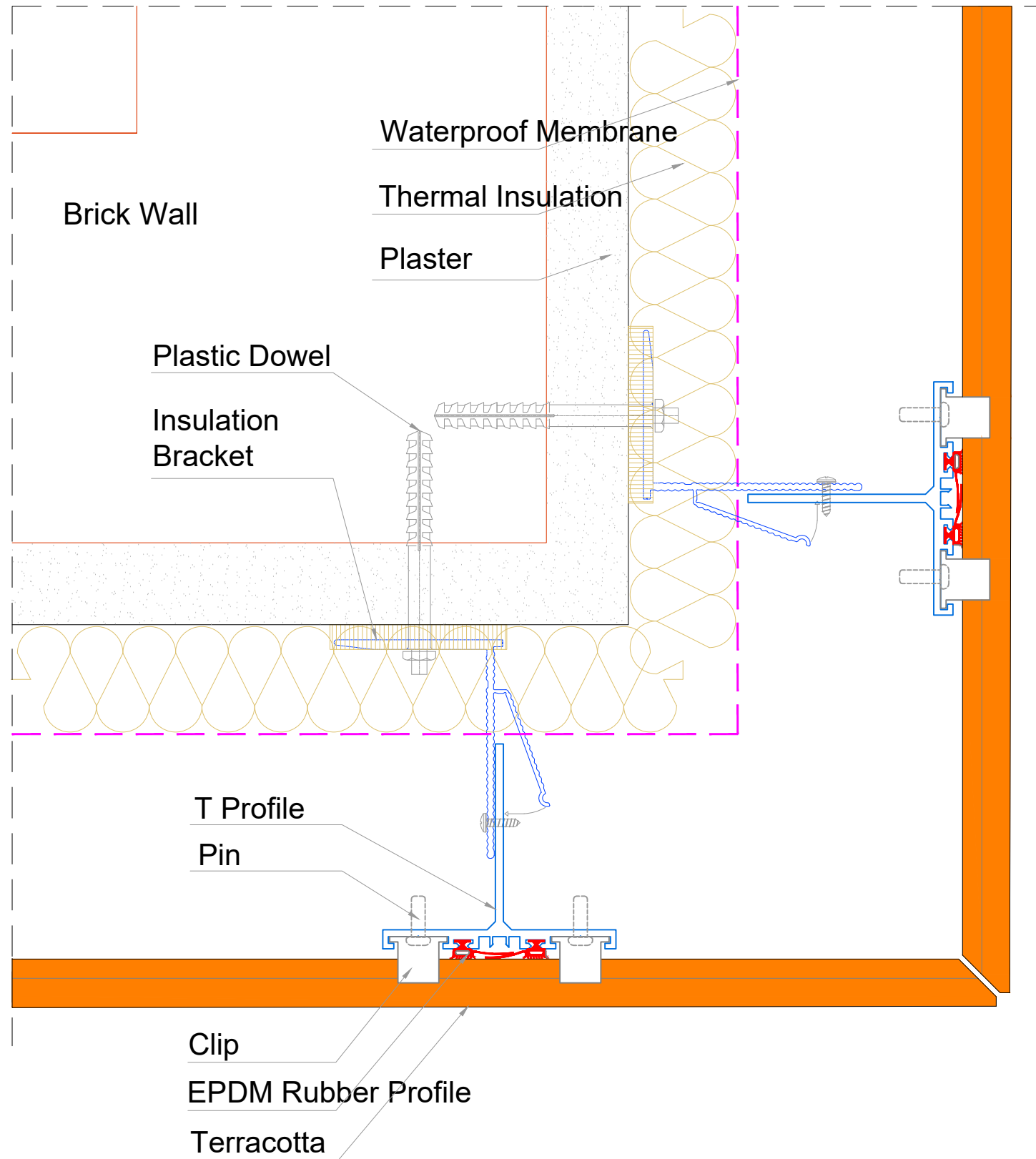

DETAIL 3 A

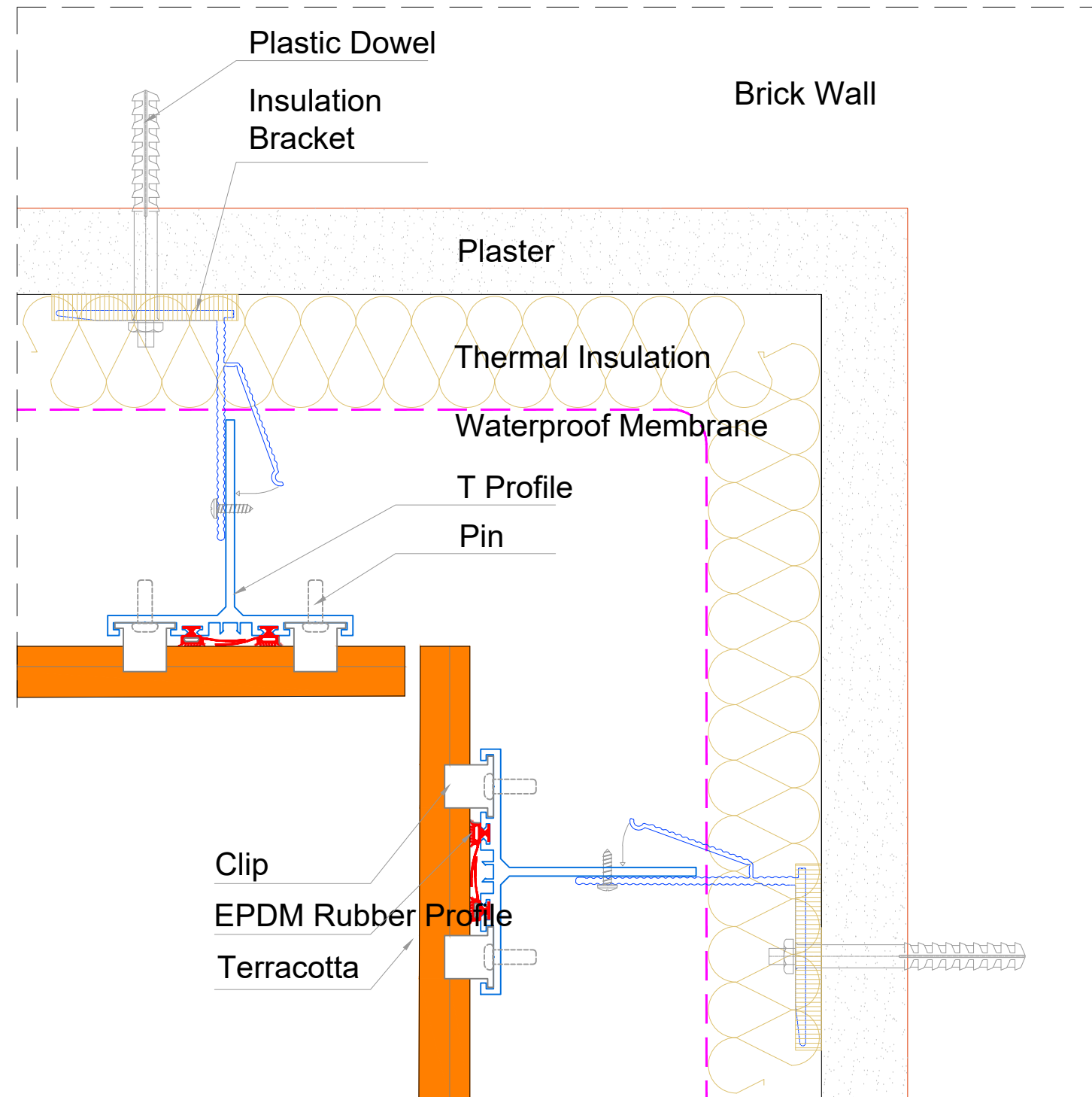

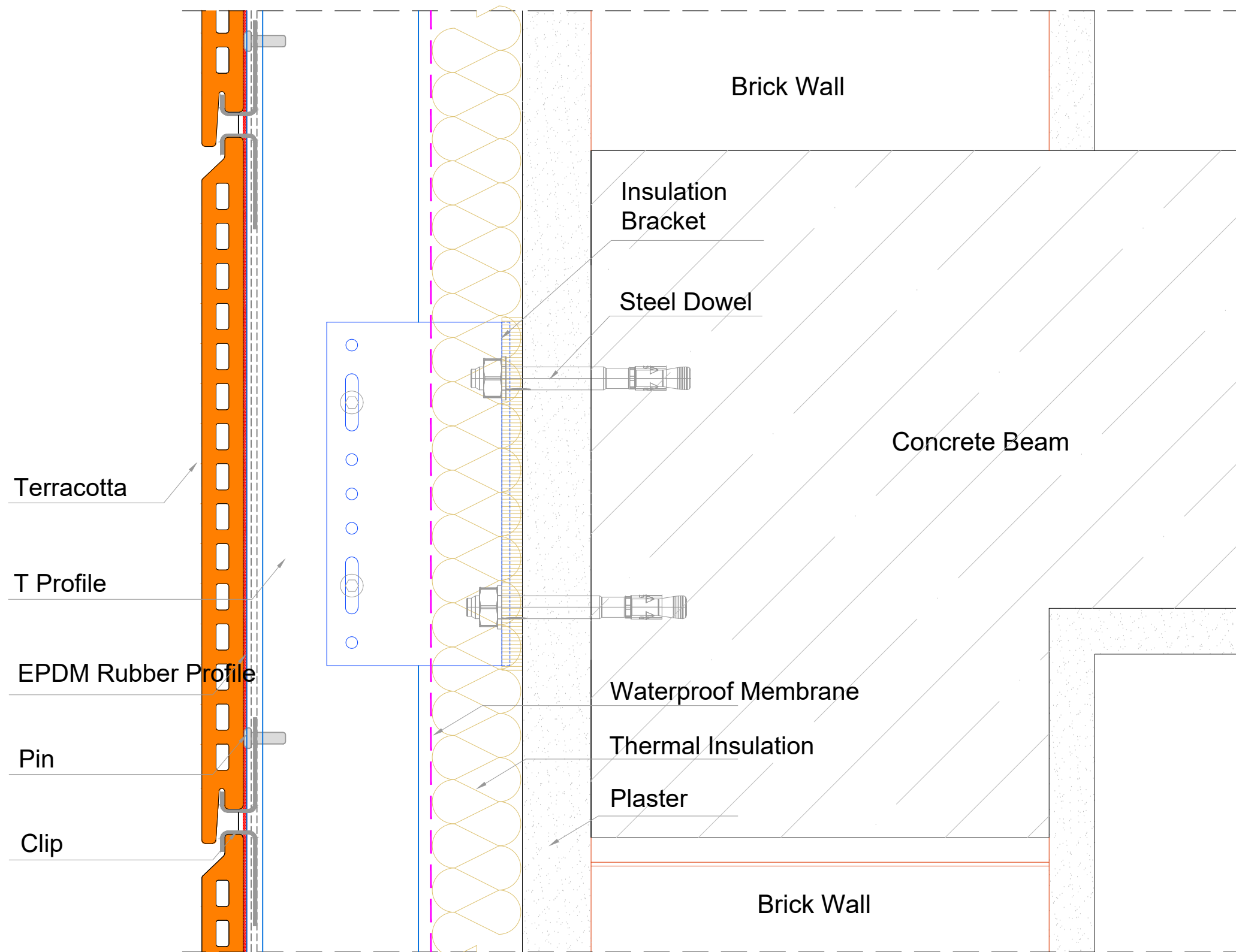

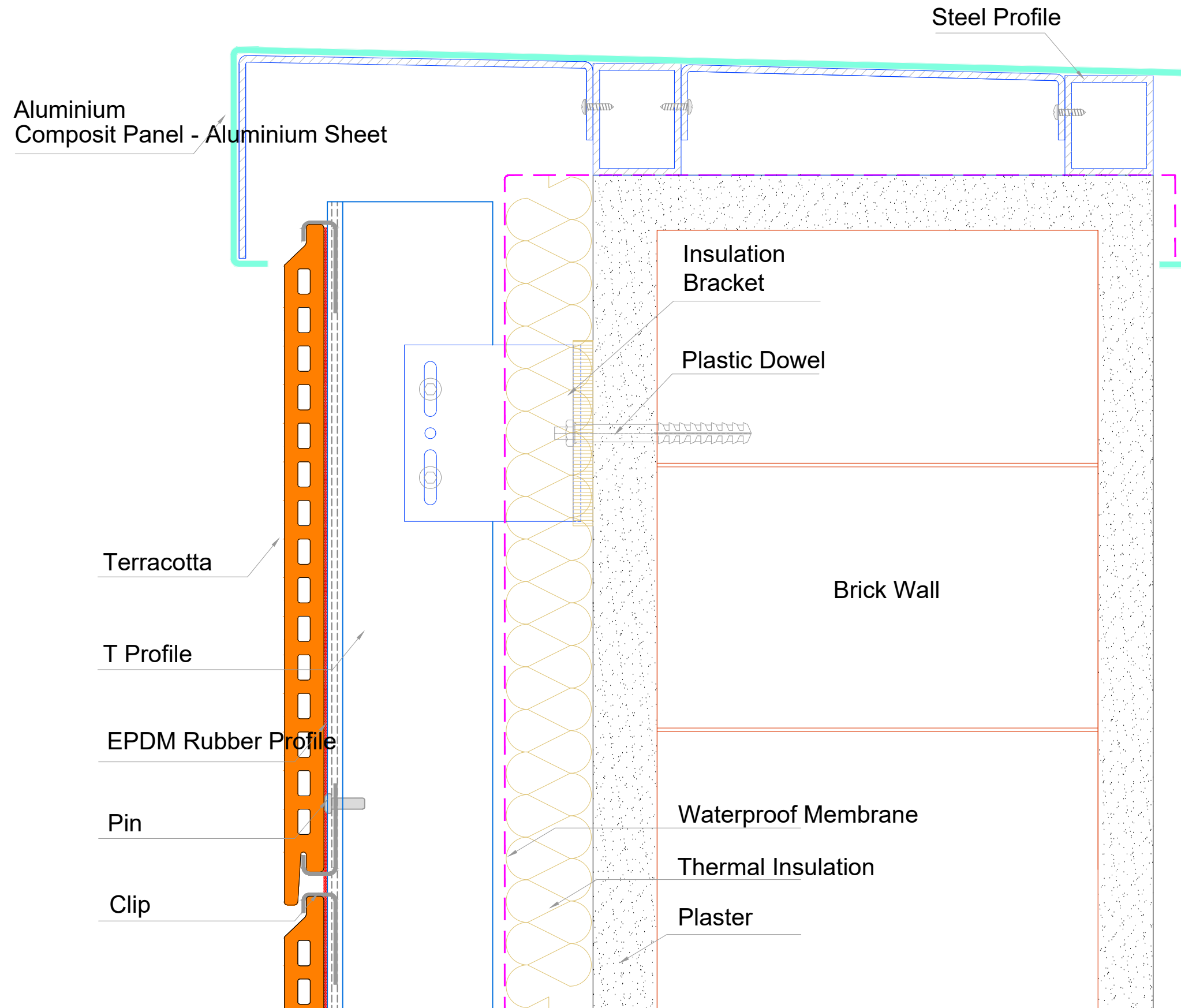

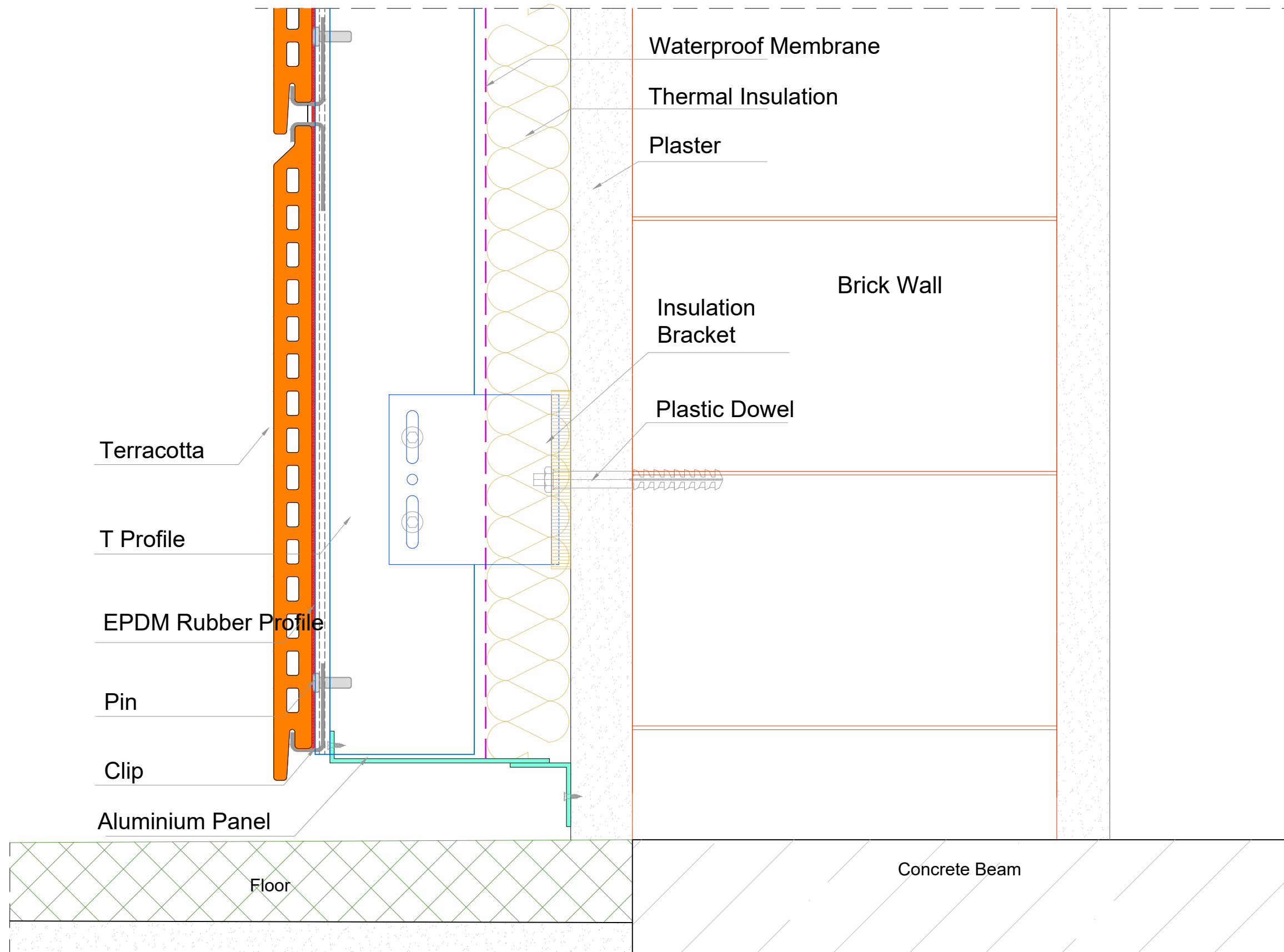

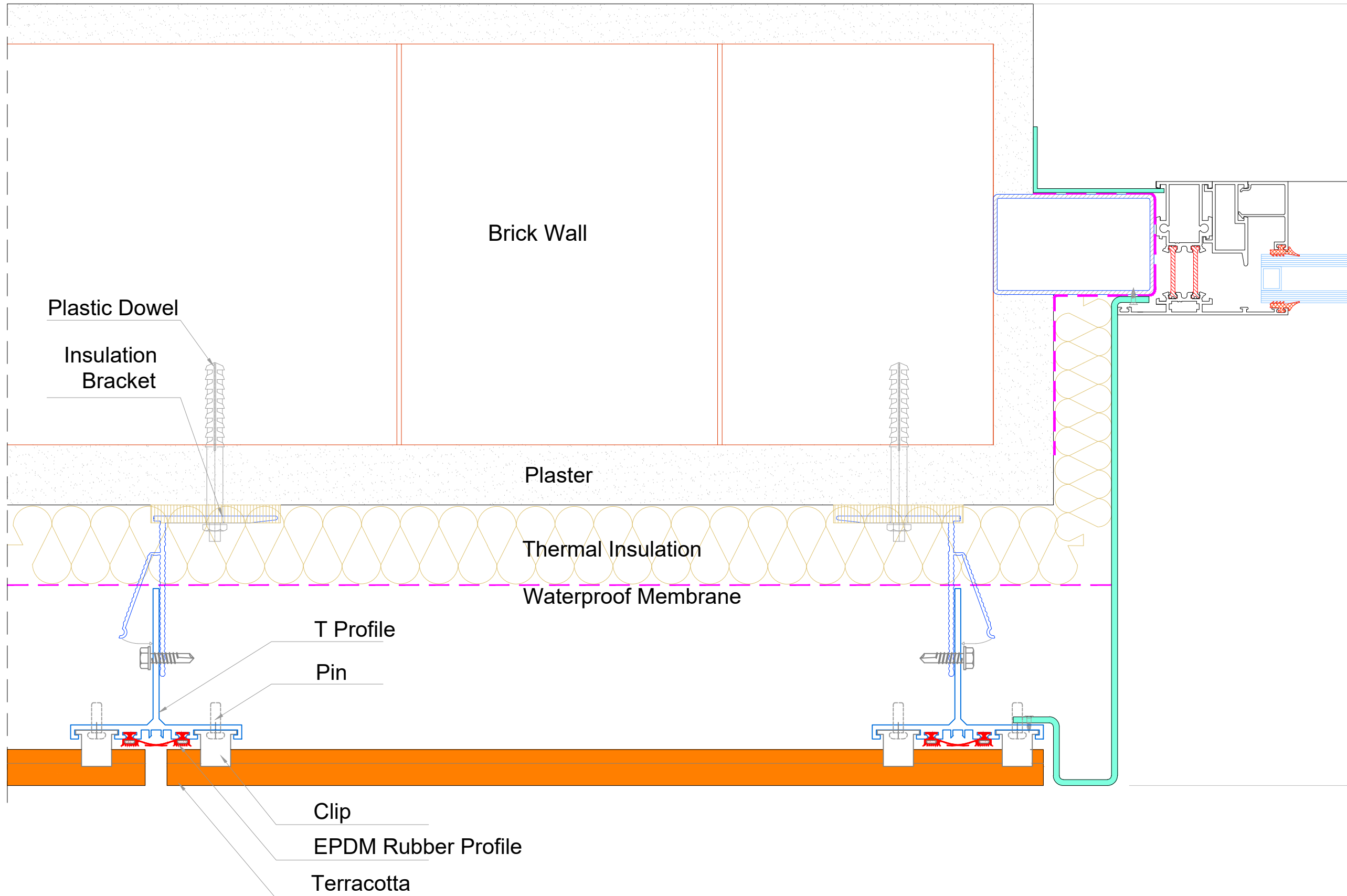

DETAIL 8

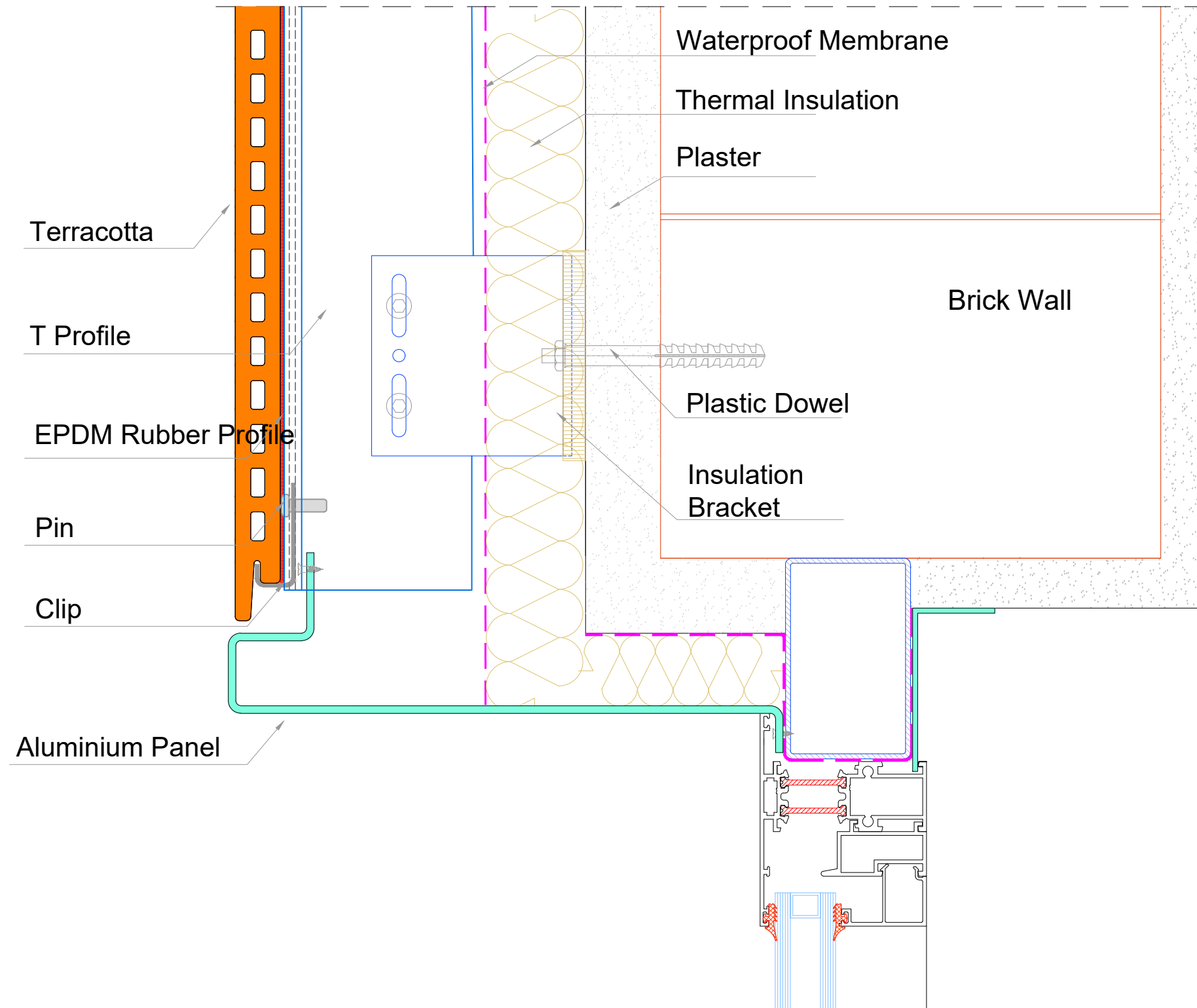

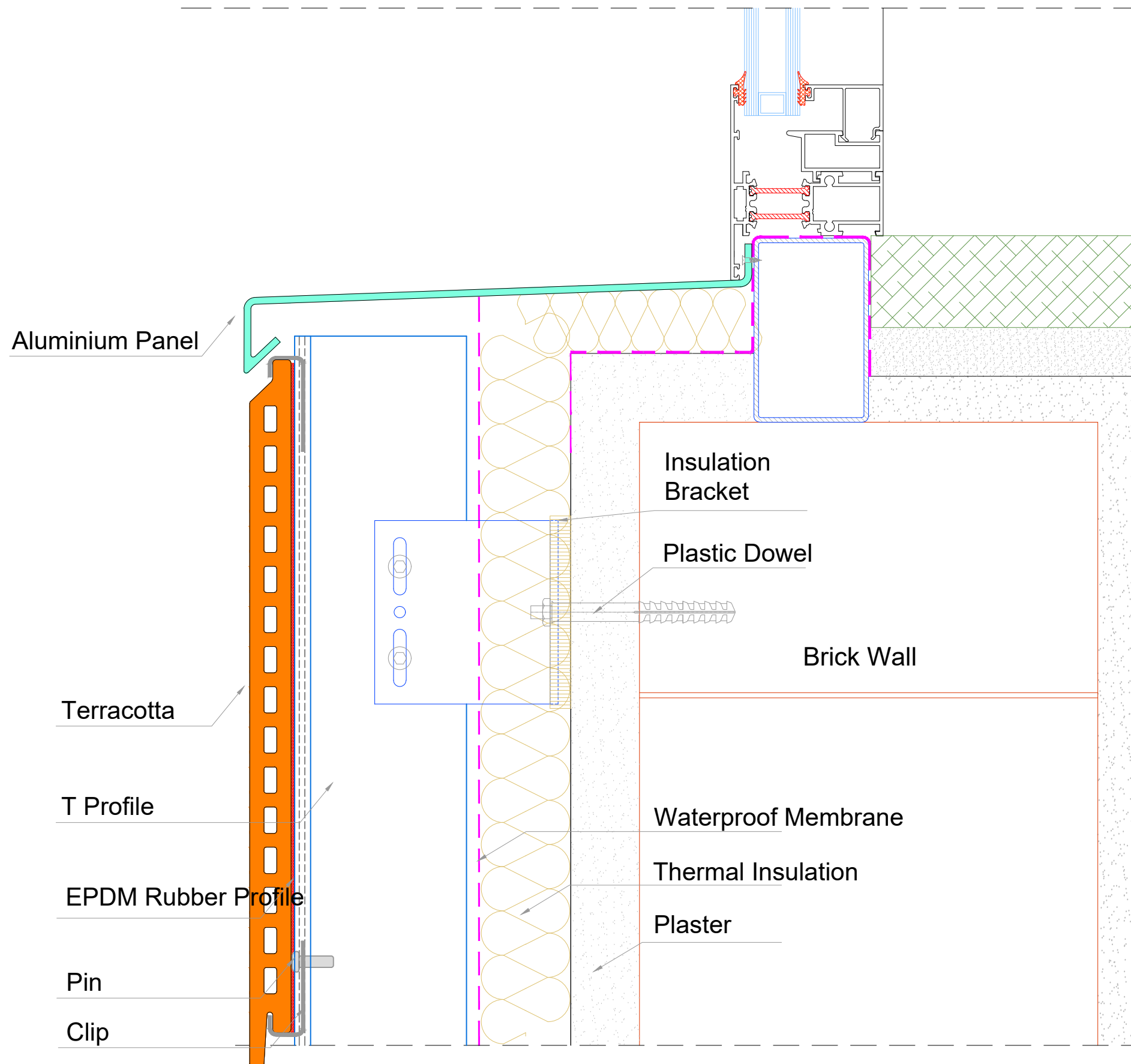

DETAIL 10

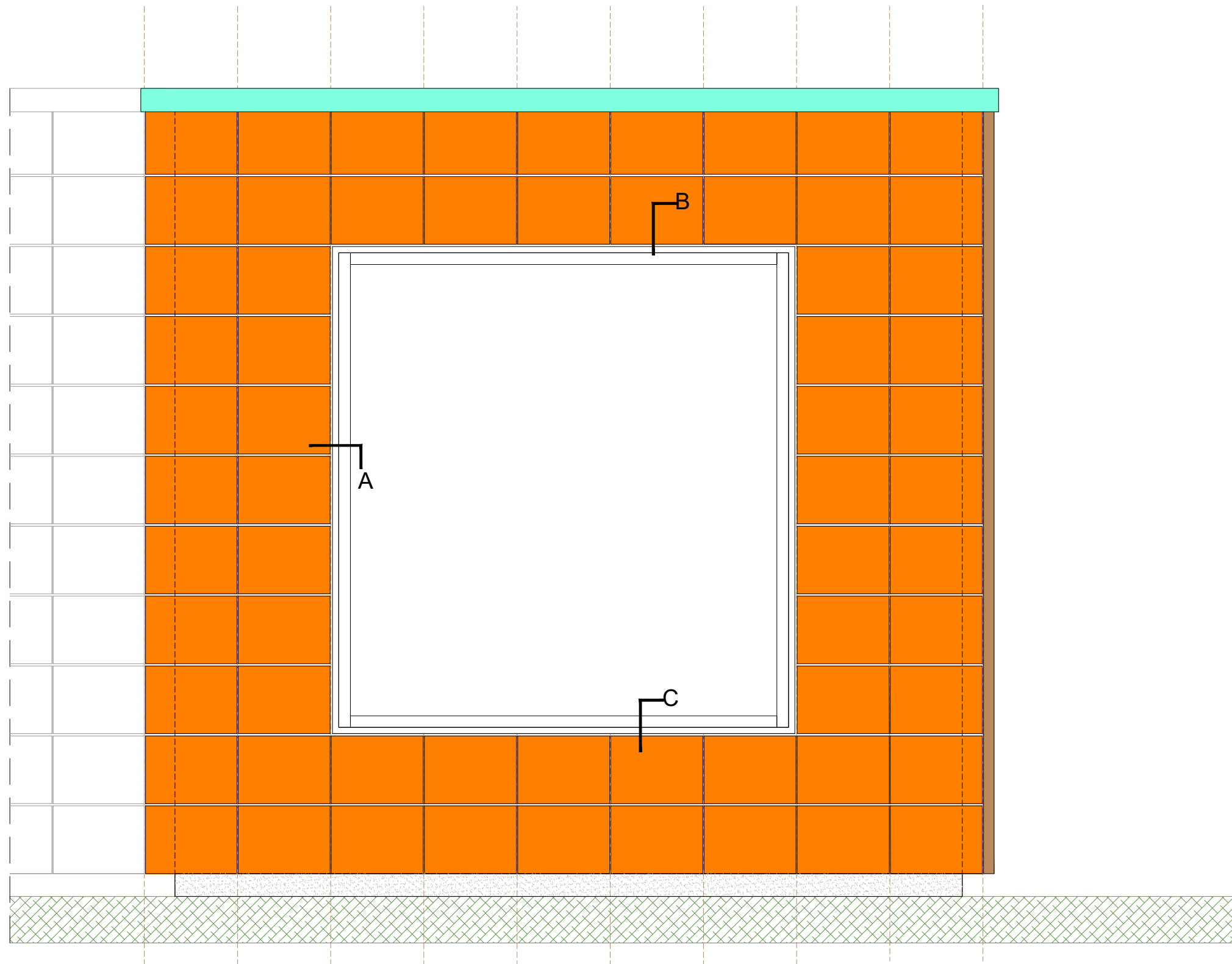

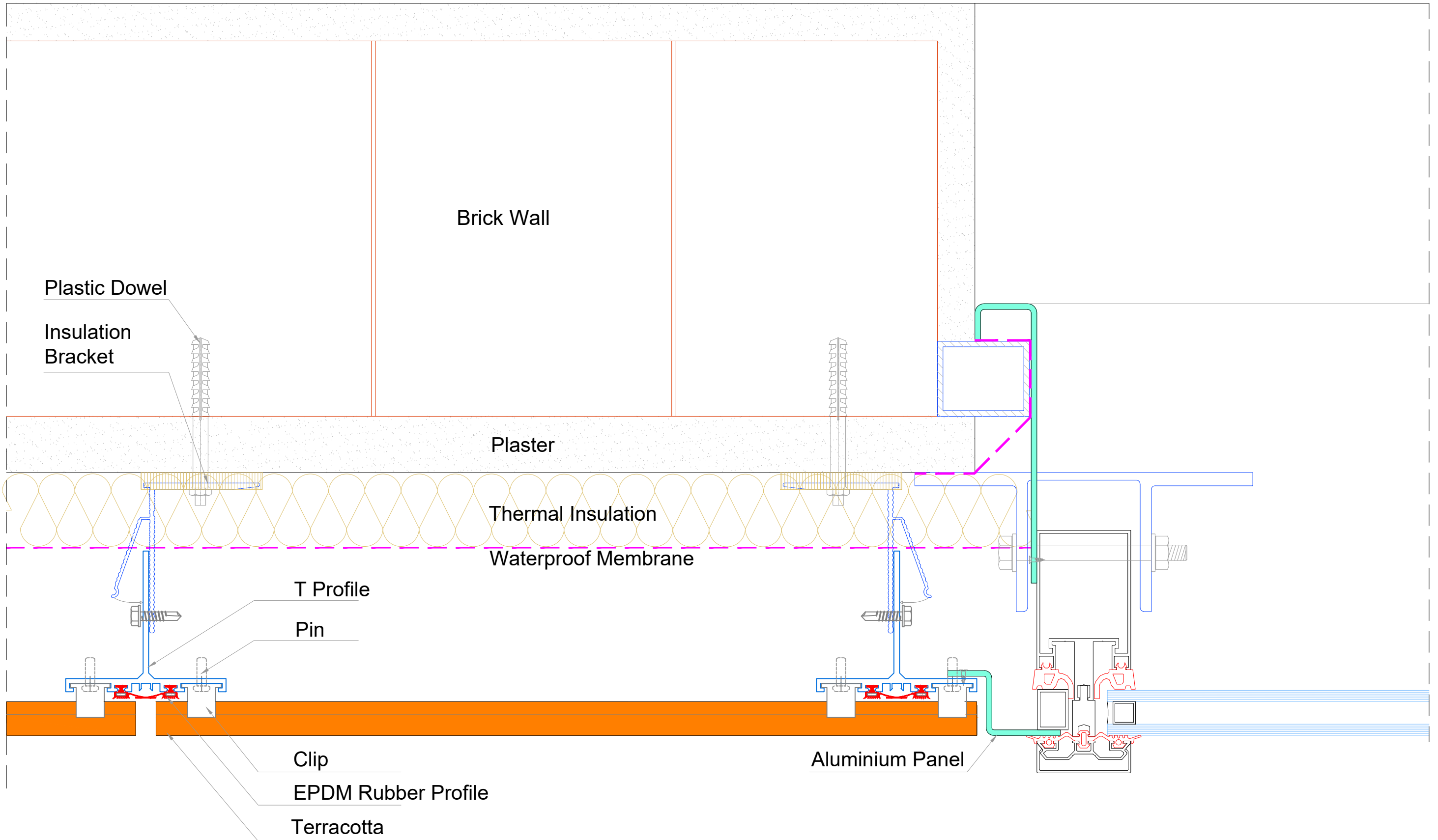

DETAIL A

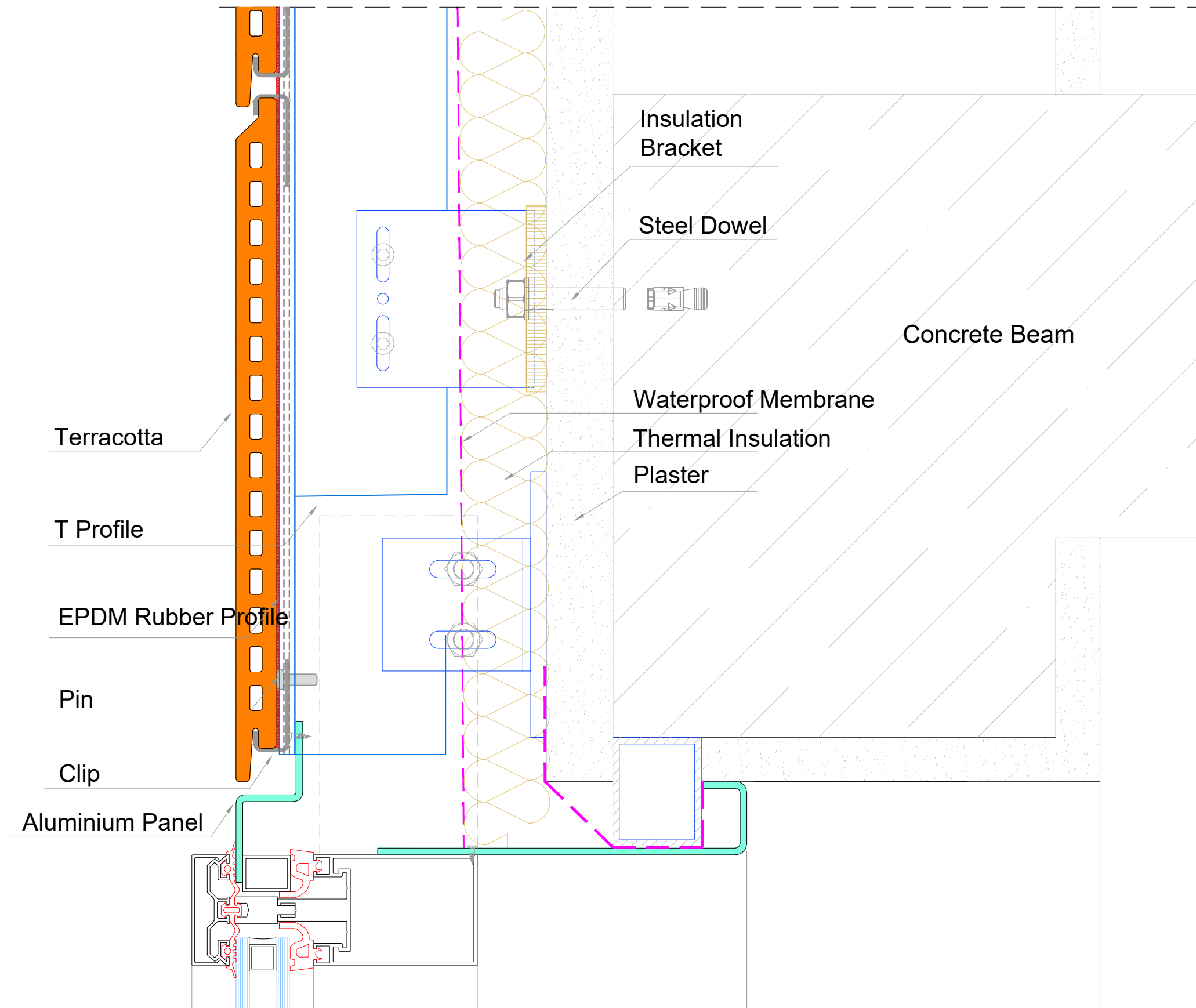

DETAIL B

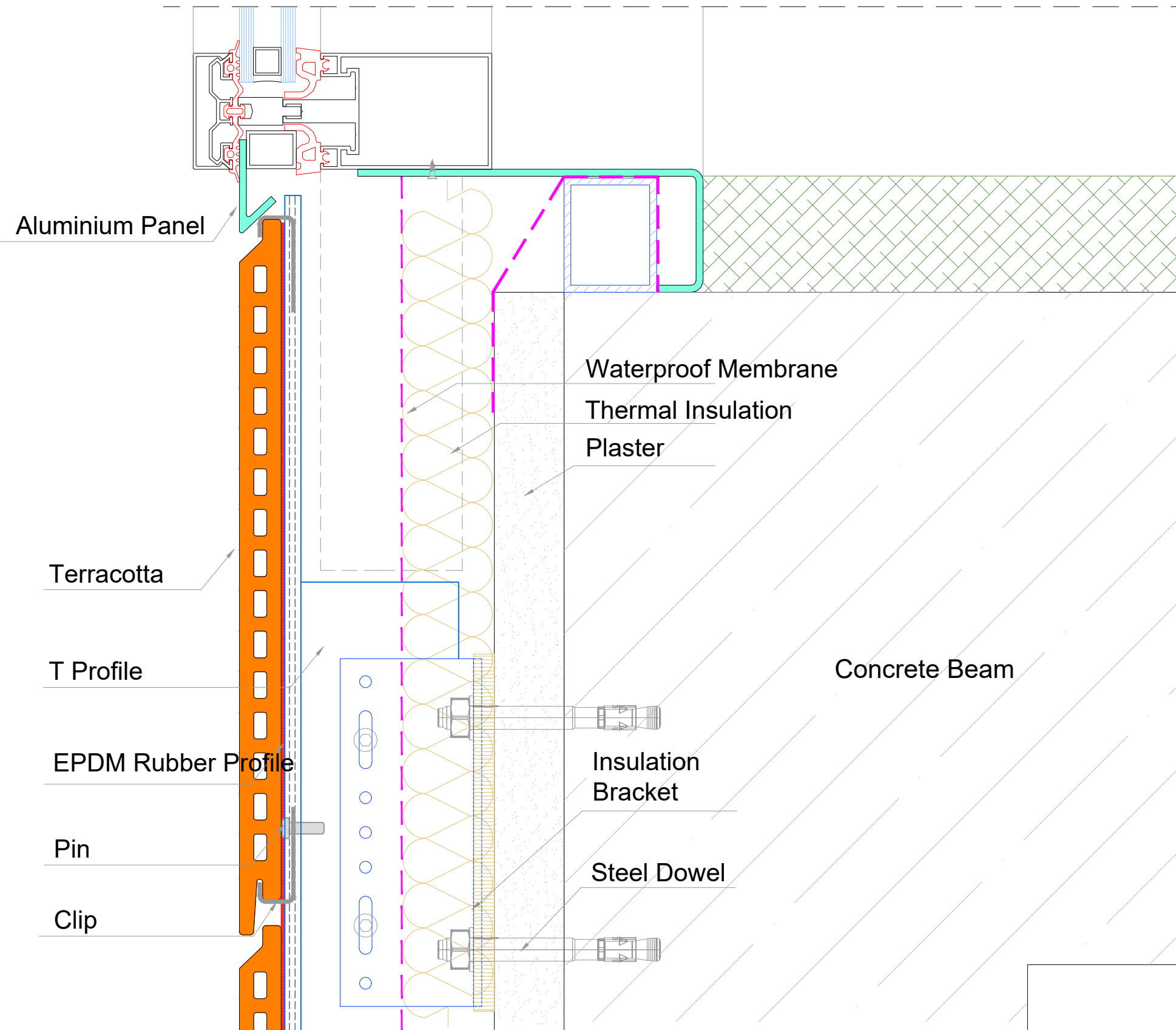

DETAIL C